

CAUTION: There are two sharp needles that puncture the K-Cup® portion pack, one above the K-Cup Holder and the other in the bottom of the K-Cup Holder.

To avoid risk of injury, do not put your fingers in the K-Cup Chamber.

CAUTION: There is extremely hot water in the K-Cup Holder during the brew process.

To avoid risk of injury, do not lift the Handle or open the K-Cup Chamber during the brew process.

SHORT CORD INSTRUCTIONS: A short power supply cord is provided to reduce the risk of becoming entangled in or tripping over a longer cord.

If an extension cord is used, (1) the marked electrical rating of the cord set or extension cord should be at least as great as the electrical rating of the appliance, (2) the cord should be arranged so that it will not drape over the countertop or table-top where it can be pulled on by children or tripped over unintentionally and (3) the extension cord must include a 3-prong grounding plug.

THIS PRODUCT IS FOR **HOUSEHOLD USE ONLY.**



WARNING: TO REDUCE THE RISK OF FIRE OR ELECTRIC SHOCK, DO NOT REMOVE THE BOTTOM COVER. NO USER SERVICEABLE PARTS ARE INSIDE. REPAIR SHOULD BE DONE BY AUTHORIZED SERVICE PERSONNEL ONLY.

KEURIG® GOURMET SINGLE CUP HOME BREWING SYSTEM

Elite - Model B40 Use & Care Guide

TABLE OF CONTENTS

SECTION 1

SET-UP & OPERATION

Helpful Hints	4
Unpacking	4
Features	5
Set-Up & First Brew	6

SECTION 2

CONTROLS & INDICATORS

LED Control Center	8
--------------------------	---

SECTION 3

CLEANING & MAINTENANCE

Cleaning	9
De-Scaling	9
Storage	10

SECTION 4

TROUBLESHOOTING	11
-----------------------	----

SECTION 5

WARRANTY	12
----------------	----

Pour des directives en Français, veuillez vous reporter à la page 13.

Record your Brewer Serial Number here.
The Serial Number is located on the bottom of the Brewer on a white sticker.

SECTION 1

SET-UP & OPERATION

Helpful Hints

1. Keep your Brewer turned 'ON' at all times.

To brew a fresh cup of coffee or tea anytime you want, we suggest you keep your Brewer turned 'ON' all the time.

However, you can set the Brewer to automatically turn off two hours after your last brew.

Follow the simple instructions on page 8 to make using the Brewer convenient for you.

2. For the best tasting gourmet coffee or tea, Keurig recommends using bottled or filtered water.

Water quality varies from place to place. If you notice an undesirable taste in your cup of coffee such as chlorine or other mineral taste, we recommend you consider using bottled water or water from a filtration system.

3. Plug Brewer into its own grounded outlet.

If the electric circuit is overloaded with other appliances, your Brewer may not function properly. The Brewer should be operated on its own circuit, separate from other appliances.

4. Brewing into a travel mug.

To brew into a travel mug, simply remove the Drip Tray Assembly and place the travel mug on the Drip Tray Base.

Unpacking Instructions

1. Place Brewer box on a large steady surface (such as a table or countertop) or on the floor. Open the box.
2. Remove the Quick Start Guide, Use & Care Guide and other literature.
3. Remove the package of complimentary K-Cup® portion packs.
4. Turn the box on its side with front of box face down.
5. Reach into the box and grasp the plastic bag that contains the Brewer.
6. Carefully pull the plastic bag (and packaging materials) toward you and out of the box. The Brewer will still be encased in the polyfoam and be on its side.
7. Remove the top polyfoam packaging material.
8. Carefully lift Brewer off of the bottom polyfoam and place it upright on a flat, steady surface.
9. Lift plastic bag off of Brewer.
10. Carefully turn the Brewer on its side and record on page 3 of this book the Serial Number located on the white sticker on the bottom of the Brewer. The Serial Number is also located on the bottom of the Brewer box.
11. Place the Brewer upright on a flat, steady surface. Remove tape holding Water Reservoir in place.

We recommend you save all packing materials in case future shipping of the product is necessary.

WARNING: Keep all plastic bags away from children.

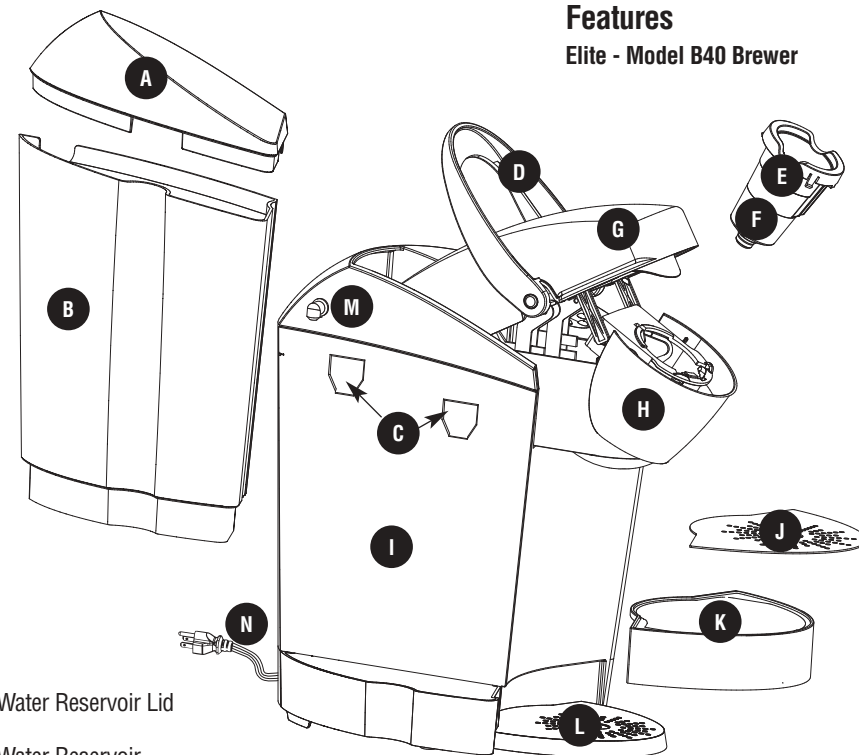

Features Elite - Model B40 Brewer

- A Water Reservoir Lid
- B Water Reservoir
- C Water Reservoir Lock Tab Slots
- D Handle
- E K-Cup® Portion Pack Holder (E and F are the K-Cup Holder Assembly)
- F Funnel
- G Lid
- H K-Cup® Portion Pack Assembly Housing
- I Housing
- J Drip Tray Plate
- K Drip Tray
- L Drip Tray Base
- M Vent
- N Power Cord

Controls and Indicators

- O Brew Button
- P Brew Light (Green)
- Q Power Button
- R Power Light (Green)
- S Auto Off Button
- T Auto Off Light (Green)
- U Heating Light (Red)
- V De-Scale Light (Red)
- W Add Water Light (Blue)

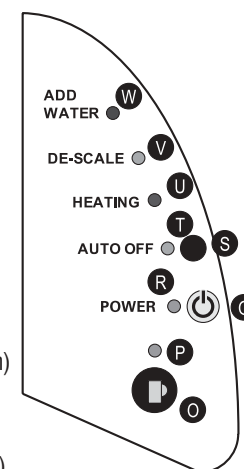

Set-Up & First Brew

IMPORTANT: You cannot use your Keurig brewer until it has been primed for its first use as set forth below.

NOTE: If Brewer has been exposed to temperatures below freezing, allow Brewer at least two hours to reach room temperature before priming. A frozen or extremely cold brewer will not prime properly and can cause damage.

Priming your Brewer

1. Unwrap cord and plug the brewer into a grounded outlet.
2. Place a cup or mug on the Drip Tray Plate.
3. Remove the Water Reservoir from Brewer by first removing Lid from Reservoir, then lifting Reservoir straight up and away from Brewer (may be tight). Rinse with fresh water.
4. Fill Water Reservoir with fresh water so that the water level reaches the line just below the top edge of the clear viewing area. (Be careful not to over fill.)
5. Place Water Reservoir base into the left side of the Brewer and be sure the Water Reservoir Lock Tabs engage with the Brewer. Replace Lid on Water Reservoir.

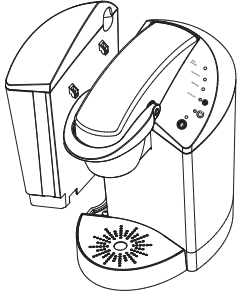

6. Press Power Button found on upper right panel of the Brewer. The green light next to the Power Button will become illuminated.
7. The red light next to 'DE-SCALE' on the LED Control Center will flash to indicate the Brewer needs to be primed. Make sure the handle is all the way down before

continuing. Please note, a K-Cup should not be used for the Priming Sequence.

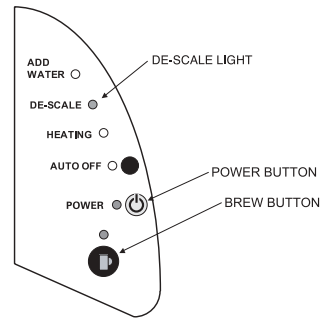

8. Press the Brew Button below the flashing green light.

NOTE: If the Water Reservoir is empty or not in place on the Brewer, then the blue light next to 'ADD WATER' on the LED Control Center will be illuminated. The Brew Button will not be activated until water is added to the Water Reservoir.

9. The Brewer will automatically fill with water (priming it) and then the water will be heated. This will take about 3 minutes. During the heating period the red light next to 'HEATING' on the LED Control Center will become illuminated. Once the water is heated, the red light will turn off and the green light above the Brew Button will flash.

NOTE: You may see small amounts of water coming from the Vent and dripping into the Water Reservoir during this and subsequent heating – this is normal.

10. Press the Brew Button below the flashing green light to start a cleansing brew, during which hot water will flow into your cup or mug. Pour the hot water into the sink.
11. The Brewer may take 15 seconds to reheat water between brews during which time the red light next to 'HEATING' on the LED Control Center may be illuminated. When the water has heated, the red light will turn off.
12. The one-time priming process is now complete and you are ready to brew!

Ready to Brew your First Cup

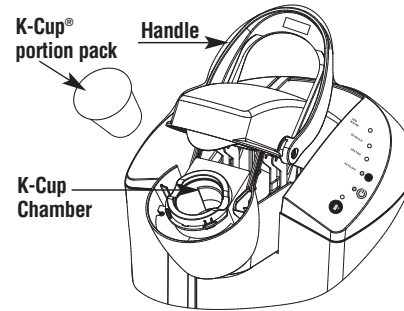

1. The green light next to the Power Button on the LED Control Center will be illuminated to indicate the Brewer is powered on.
2. Place a cup or mug on the Drip Tray Plate.
3. Lift the Handle and the K-Cup Holder will open toward you.

CAUTION: There are two sharp needles that puncture the K-Cup[®] portion pack, one above the K-Cup Holder and the other in the bottom of the K-Cup Holder. To avoid risk of injury, do not put your fingers in the K-Cup Chamber.

4. Select a K-Cup[®] portion pack.

NOTE: Do not remove the foil lid or puncture the K-Cup[®] portion pack.



5. Place a K-Cup[®] portion pack in the K-Cup Holder (as shown in exhibit at top of page).
6. Lower the Handle completely to close the Lid.
7. Press the Brew Button below the flashing green light on the LED Control Center. This will yield a 7.25 oz serving.

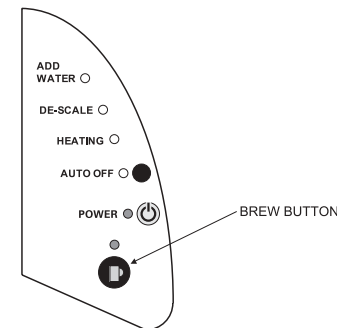

NOTE: If you do not push the Brew Button in 60 seconds, the Brew Button will be disabled to prevent accidental activation. Re-activate the Brew Button by raising and lowering the Handle completely.

8. The green light above the Brew Button on the LED Control Center will remain lit while brewing.

CAUTION: There is extremely hot water in the K-Cup Holder during the brew process. To avoid risk of injury, do not lift the Handle or open the K-Cup Chamber during the brew process.

9. There may be a short pause before the brewing process begins. The process lasts for approximately 40 seconds and ends with a burst of air to remove all liquid coffee or tea from the K-Cup.
10. Lift the Handle to remove and dispose of the used K-Cup. **CAUTION: K-Cup will be hot.**
11. Enjoy your first cup of Keurig Brewed[®] gourmet coffee or tea!
12. The red light next to 'HEATING' on the LED Control Center may be lit as the water is heated for the next brew cycle. The Brewer will be ready for use in approximately 15 seconds.

NOTE: Following the brew, your Brewer will fill in preparation for the next brew. The pump will make a vibrating sound. This is normal.

Stopping the Brew Process

If you need to stop the brewing after the process has started, press the Power Button to turn the Brewer 'OFF'. The flow of coffee or tea will stop, the heating element will shut off and the green light next to the Power Button will disappear.

NOTE: You may get less coffee or tea in your cup during your next brew. We recommend that you perform a cleansing brew with water only after a terminated brew. Then your NEXT brew will be the proper volume.

SECTION 3

CLEANING & MAINTENANCE

Cleaning External Parts

Regular cleaning of the Brewer's external components is recommended.

1. Never immerse the base unit in water or other liquids. The Housing and other external components may be cleaned with a soapy, damp, non-abrasive cloth.
2. The Drip Tray can accumulate up to 8 ounces of overflow. The Drip Tray and Drip Tray Plate should be periodically inspected and rinsed clean. To remove the Drip Tray Assembly, simply slide it toward you, keeping it level at all times to avoid spilling. The Drip Tray and Drip Tray Plate are dishwasher safe.

Cleaning the K-Cup® Portion Pack Holder Assembly

1. Cleaning the Parts

The K-Cup Holder Assembly is dishwasher safe. To remove from the Brewer, open the cover by lifting the Handle. Grasp the top of the K-Cup Holder with one hand while pushing up on the bottom of the K-Cup Holder from underneath with the other until it releases. After cleaning, align the K-Cup Holder with the opening using the two front ribs as a guide and snap into place from the top.

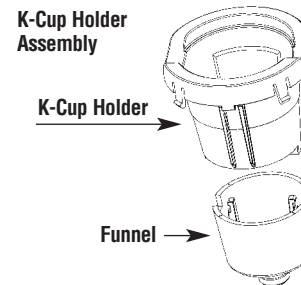

2. Cleaning the Funnel

The Funnel can be removed from the K-Cup Holder by pulling on it until it snaps off. The Funnel is dishwasher safe. To replace it just snap it back onto the K-Cup Holder Assembly.

3. Cleaning the Exit Needle

The Exit Needle is located on the inside bottom of the K-Cup Holder Assembly. Should a clog arise due to coffee grinds, it can be cleaned using a paper clip or similar tool. Remove K-Cup Holder, insert the paper clip into the Needle to loosen the clog and push it out. The K-Cup Holder is dishwasher safe.

CAUTION: There are sharp needles that puncture the K-Cup above the K-Cup Holder and in the bottom of the K-Cup Holder. To avoid risk of injury, do not put your fingers in the K-Cup Chamber.

Cleaning the Water Reservoir and Water Reservoir Lid

The Water Reservoir Lid should be cleaned with a damp soapy non-abrasive cloth. Lid should **not** be put into the dishwasher.

The Water Reservoir can be placed into the dishwasher for cleaning or can be cleaned with soapy water and rinsed thoroughly.

Do not dry the inside of the Water Reservoir with a cloth as lint may remain.

CAUTION: Please rinse the Water Reservoir thoroughly after cleaning to ensure that no cleaners or cleaning solutions remain in this area as they may contaminate the water supply in the Brewer.

De-Scaling Your Brewer

Mineral content in water varies from place to place. Depending on the mineral content of the water in your area, calcium deposits or scale may build up in your Brewer. Scale is non-toxic, but left unattended, it can hinder Brewer performance. De-scaling your Brewer helps maintain the heating element, and other internal parts of the Brewer that come in contact with water.

The Brewer should be de-scaled every 6 months to ensure optimal performance. It is

Adding Water

The LED Control Center of your Brewer will indicate when the water level in the tank is low or if the Water Reservoir has been removed by illuminating the blue light next to 'ADD WATER'. The Brewer will not allow you to brew when the blue 'ADD WATER' light is illuminated.

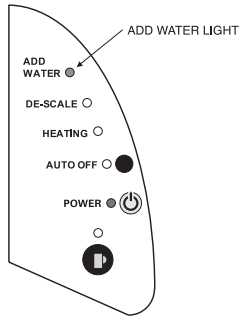

The Water Reservoir can be filled in two ways.

1. Lift off the Water Reservoir Lid and pour water directly into the Water Reservoir while it is still attached to the Brewer, then replace the Lid.
2. Remove the Water Reservoir from Brewer by first removing Lid from Reservoir, then lifting Reservoir straight up and away from Brewer. Fill with water. Place the Water Reservoir back on the Brewer and replace the Lid.

IMPORTANT: Do not remove the Water Reservoir during the brewing process.

Brewing Hot Water

Your Brewer is able to produce a cup of hot water for making hot chocolate, for use in cooking, for making soups, etc. Simply raise and lower the handle on the Brewer without adding a K-Cup® portion pack. The green light above the Brew Button on the LED Control Center will flash. Be sure to have a mug or cup on the Drip Tray and then press the Brew Button.

Purging the Brewer

If your Brewer has not been used for more than one week, you should purge the water from the inner tank.

1. If there is water in the Water Reservoir, remove the Lid, then lift Reservoir straight up and away from Brewer. Discard water, rinse and refill with water. Place the Water Reservoir back on the Brewer and replace the Lid. (If there is no water in Reservoir, simply refill.)
2. Be sure the Brewer is turned on. Raise and lower the handle on the Brewer without inserting a K-Cup and wait until the red light next to 'HEATING' turns off.
3. The green light above the Brew Button on the LED Control Center will flash. Be sure to have a mug or cup on the Drip Tray and then press the Brew Button.
4. Repeat steps 2 and 3 two more times to completely purge water from inner tank.

If you are experiencing any problems with your Brewer, please contact Customer Service at 1-866-901-BREW (2739).

SECTION 2

CONTROLS & INDICATORS

LED Control Center

Programming Auto off Timer Feature

Set the Brewer to turn off two hours after the last brew.

- a. Press the Power Button to turn on the Brewer.
- b. Press the black button above the Power Button on the LED Control Center to turn on the Auto Off Timer feature. The green light next to 'AUTO OFF' will become illuminated. When the Auto Off Timer is enabled, your Brewer will automatically turn off two hours after your last brew.
- c. To turn off the Auto Off Timer, simply press the black button again and the green light next to 'AUTO OFF' will turn off.

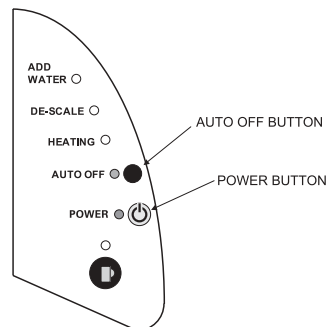

SECTION 4

TROUBLESHOOTING

SITUATION	SOLUTION
-----------	----------

Brewer Does Not Have Power	<ul style="list-style-type: none">• Plug Brewer into an independent outlet.• Check to be sure that it is plugged in securely.• Plug into a different outlet.• Reset circuit breaker if necessary.• Make sure that the Power Button has been turned on and the power light is illuminated.
-----------------------------------	---

Brewer will not brew when used for the first time	<ul style="list-style-type: none">• The Brewer must be primed for use by filling the internal hot water tank before the first brew. The red light next to 'DE-SCALE' on the LED Control Center will flash. (refer to page 6)• If Brewer is cold/frozen, wait for two hours for it to reach room temperature before powering on.
--	--

Brewer will not brew	<ul style="list-style-type: none">• After placing the K-Cup® portion pack in the K-Cup Holder, make sure that the Handle is pushed down securely and the green light above the Brew Button on the LED Control Center is flashing.• If the blue light next to 'ADD WATER' on the LED Control Center is illuminated, add water to Water Reservoir or make sure the Water Reservoir is seated properly in its base.• If the blue light next to 'ADD WATER' on the LED Control Center continues to be on even after refilling, contact Customer Service at 1-866-901-BREW (2739).
-----------------------------	---

Brewing a partial cup	<ul style="list-style-type: none">• The Exit Needle may be clogged. (refer to page 9).• Clean K-Cup Holder if necessary and rinse under faucet. (refer to page 9).• The Water Reservoir may have been removed during brewing. Replace the Water Reservoir and perform a cleansing brew.• If the red 'DE-SCALE' light is illuminated, descale the Brewer (refer to page 9).• If you have repeated the descale procedure on your Brewer two times and the light is still on, contact Customer Service at 1-866-901-BREW (2739).
------------------------------	---

My brewer shuts off automatically	<ul style="list-style-type: none">• Check to make sure that the Auto Off Timer feature has not been set. If the green light next to 'AUTO OFF' on the LED Control Center is illuminated, press the black button to turn off the Auto Off Timer feature.
--	---

possible for calcium deposits to build up faster, making it necessary to de-scale more often.

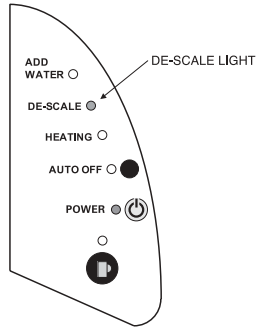

This Brewer is equipped with sensors to detect when scale buildup is interfering with the performance of the Brewer. When this is detected, the red light next to 'DE-SCALE' will be illuminated.

NOTE: The Brewer will continue to function even when the red 'DE-SCALE' light is illuminated. However, if you do not de-scale soon after it is displayed, continued scale build-up could damage the Brewer. If this occurs, the red light next to 'DE-SCALE' will begin to blink to alert you to the potential damage to the Brewer if you do not de-scale immediately.

You should promptly de-scale using the procedures outlined below once the 'DE-SCALE' light illuminates on the LED Control Center.

De-Scaling

a. PREPARE

Step 1: Make sure you have at least 48 ounces of undiluted white vinegar on hand. You will also need an empty sink and a ceramic cup (do not use a paper cup.)

Step 2: Empty the water in the Water Reservoir.

b. FILL AND CLEAN

Step 1: Pour the vinegar into the Water Reservoir and fill it to the line just below the top edge of the clear viewing area.

Step 2: Place a ceramic cup in the Drip Tray and run a brew cycle. **DO NOT USE A K-CUP® portion pack** just press the Brew Button.

Pour the contents of the cup into the sink.

Step 3: Repeat the brew process until the Water Reservoir is empty, pouring the contents of the cup into the sink after each cycle. Remember to open and close the lid between each cycle so the green Brew light will flash.

Step 4: Rinse the Water Reservoir thoroughly and fill with fresh water.

Step 5: Now let the Brewer stand for 4 hours while still on.

c. RINSE

Step 1: Ensure the Water Reservoir is filled with fresh water.

Step 2: Place a ceramic cup on the Drip Tray and run a regular brew cycle without using a K-Cup. Pour the contents of the cup into the sink.

Step 3: Repeat brew process until the Water Reservoir is empty.

Step 4: You may need to perform additional rinse cycles if you notice any residual taste.

NOTE: If the red 'DE-SCALE' light is still illuminated on the LED Control Center after completing the procedure, repeat the de-scaling procedure above.

Storage

Empty the Water Reservoir before storing and take care to ensure that you store your Brewer in a safe and **frost free** environment. Please be sure to store your Brewer in its upright position to avoid water leakage from the inner tank. If you store the Brewer in a cold environment, you run the risk of water freezing inside the Brewer and causing damage. When you prepare to use it after storage, we recommend rinsing the Water Reservoir with fresh water and running three cleansing brews without a K-Cup.

If you plan to move your Brewer to a different location, turn the Brewer off, unplug it and empty the Water Reservoir. If your Brewer has been in an environment below freezing, please be sure to let it warm to room temperature for 2 hours before using.

If any problems persist, contact Customer Service at 1-866-901-BREW (2739).

SECTION 5

WARRANTY

Limited One Year Warranty

Keurig warrants that your Brewer will be free of defects in materials or workmanship under **normal home use** for one year from the date of purchase. It is recommended that you fill out and return the warranty card enclosed with your Brewer so that your purchase information will be stored in our system. Keurig will, at its option, repair or replace the Brewer without charge upon its receipt of proof of the date of purchase. If a replacement Brewer is necessary to service this warranty, the replacement Brewer may be new or reconditioned. If a replacement Brewer is sent, a new limited one year warranty will be applied to the replacement Brewer.

This warranty only applies to Brewers operated in the United States and Canada. This warranty gives you specific legal rights, and you may also have other rights that vary from state to state and, in the case of Canada, from Province to Province.

What is not covered by the Limited Warranty?

THIS WARRANTY DOES NOT COVER CONSEQUENTIAL OR INCIDENTAL DAMAGES SUCH AS PROPERTY DAMAGE AND DOES NOT COVER INCIDENTAL COSTS AND EXPENSES RESULTING FROM ANY BREACH OF THIS WARRANTY, EVEN IF FORESEEABLE. Some states or Provinces do not allow the exclusion or limitations of incidental or consequential damages, so the above limitation or exclusion may not apply to you depending on the state or Province of purchase.

Nor does this warranty cover damages caused by services performed by anyone other than Keurig or its authorized service providers, use of parts other than genuine Keurig parts, or external causes such as abuse, misuse, inappropriate power supply or acts of God.

Other Limitations

THIS WARRANTY IS EXCLUSIVE AND IS IN LIEU OF ANY OTHER EXPRESS WARRANTY, WHETHER WRITTEN OR ORAL. THE DURATION OF ANY IMPLIED WARRANTIES, INCLUDING BUT NOT LIMITED TO ANY IMPLIED WARRANTIES OF MERCHANTABILITY OR FITNESS FOR A PARTICULAR PURPOSE, IS EXPRESSLY LIMITED TO THE PERIOD OF DURATION OF THIS LIMITED WARRANTY. Some states or Provinces do not allow limitations on how long an implied warranty lasts, so the above limitation may not apply to you depending on the state or the Province of purchase.

How do you obtain warranty service?

Keurig Brewers are high quality appliances and, with proper care, are intended to provide years of satisfying performance. However, should the need arise for warranty servicing, simply call Keurig Customer Service at our toll free phone number 1-866-901-BREW (2739). Please do not return your Brewer for servicing without first speaking to Keurig Customer Service to obtain an Authorization to Return number (ATR). Keurig Brewers returned without an ATR number will be returned to the sender without servicing.

Keurig, Incorporated
101 Edgewater Drive
Wakefield, MA 01880
1-866-901-BREW (2739)