



KEURIG®

K140 Brewer | Owner's Manual

GENERAL SAFETY INFORMATION

Safe Operation & Use

When using electrical appliances, basic safety precautions should be followed, including the following:

1. Read all instructions before using.
2. Do not touch hot surfaces. Use handles and knobs when available.
3. This appliance must be properly installed and located in accordance with these instructions before it is used.
4. The use of any accessory not designed to be used with this appliance may cause injuries.
5. Do not place on or near a hot gas or electric cooker or in a heated oven.
6. Do not use outdoors.
7. To protect against fire, electric shock and injury do not immerse Power Cords, plugs, or the appliance in water or any other liquid.
8. Use **only water** in this appliance! Do not put any other liquids or foods in the Water Reservoir except as instructed in the Cleaning Instructions in this guide.
9. Turn off and unplug the brewer before cleaning or maintenance. Allow to cool before putting on or taking off parts and before cleaning the appliance.
10. For best operation, plug the appliance

into its own power socket. This helps prevent blowing a fuse or tripping a circuit breaker.

11. Do not operate any appliance with a damaged Power Cord or plug or after the appliance malfunctions or is damaged in any way. Contact your Keurig Authorised Distributor to report any malfunction of or damage to the brewer.
12. If the Power Cord is damaged, it must be replaced by the manufacturer, its service agent or similarly qualified persons in order to avoid a hazard.
13. Do not let the Power Cord hang over the edge of the table or counter, or touch hot surfaces.
14. To disconnect, press the POWER Button on the brewer to "OFF" and then remove the plug from the power socket.
15. Close supervision is necessary when any appliance is used by or near children.
16. Do not lift the Handle while brewing is in progress.
17. Always keep the Water Reservoir Lid on the Water Reservoir unless you are refilling it.
18. This appliance is equipped with an earthed Power Cord and a 3-pin plug. Never do anything that might damage

the Power Cord or plug, such as placing hot or heavy items on them, bending, stretching, or twisting them.

19. Make sure the plug is correctly inserted into the power socket. Do not use a damaged plug or loose power socket. Never unplug the appliance with wet hands.
20. Do not use the appliance for other than its intended use.
21. Always brew with the Removable Puncture Plate (item L on page 5) installed. Failure to do so will result in a failure to properly brew.

SAVE THESE INSTRUCTIONS.

WARNING TO USERS AND PARENTS

1. **DO NOT** permit children to use brewer unless there is adult supervision. Brewer dispenses very hot water.
2. **SPECIAL NOTICE FOR HOT CHOCOLATE USERS: IMMEDIATELY AFTER USING A HOT CHOCOLATE K-CUP® POD, RUN a Hot Water Brew Cycle** without a K-Cup® pod to avoid the possibility of clogging the exit needle. **DO NOT** assume the next user will do this.

CAUTION: There are two sharp needles that puncture the K-Cup® pod, one above the K-Cup® Pod Holder and the other in the bottom of the K-Cup® Pod Holder. To avoid risk of injury, do not put your fingers in the K-Cup® Pod Assembly Housing.

CAUTION: There is extremely hot water in the K-Cup® Pod Holder during the brew process. To avoid risk of injury, do not lift the Handle or open the K-Cup® Pod Assembly Housing during the brewing process.

CAUTION: Please always keep the brewer in its upright position to avoid potential injury and/or damage to your brewer.

This appliance can be used by children aged from 8 years and above if they have been given supervision or instruction concerning use of the appliance in a safe way and if they understand the hazards involved. Cleaning and user maintenance shall not be made by children unless they are older than 8 and supervised. Keep the appliance and its cord out of reach of children aged less than 8 years.

Appliances can be used by persons with reduced physical, sensory, or mental capabilities or lack of experience and knowledge if they have been given supervision or instruction concerning use of the appliance in a safe way and understand the hazards involved.

Children shall not play with the appliance.

This appliance is intended to be used in household and similar applications as: staff kitchen areas in shops, offices, and other working environments, farm houses, by clients in hotels, motels and other residential type environments and bed and breakfast type environments.



WARNING: TO REDUCE THE RISK OF FIRE OR ELECTRIC SHOCK, DO NOT REMOVE THE BOTTOM COVER. NO USER SERVICEABLE PARTS ARE INSIDE. REPAIR SHOULD BE DONE BY AUTHORISED SERVICE PERSONNEL ONLY.

TABLE OF CONTENTS

KEURIG® SINGLE CUP BREWING SYSTEM

K140 Brewer – Using Your Brewer

BREWER OVERVIEW

Helpful Hints.....	4
Unpacking	4
Features.....	5

SECTION 1—SET-UP & FIRST BREW

Setting Up Your Brewer	6
Brewing Your First Cup.....	7
Stopping the Brew Process.....	8
Adding Water	8
Brewing Hot Water.....	9

SECTION 2—CONTROLS & INDICATORS

AUTO OFF Energy Save Feature	9
------------------------------------	---

SECTION 3—CLEANING & MAINTENANCE

Cleaning.....	10
Descaling	11
Draining & Storage	12

SECTION 4—TROUBLESHOOTING

SECTION 5—WARRANTY

Record your brewer serial number here.

See unpacking Instructions on page 4 for serial number location.

Removing the serial number label from the brewer will void warranty.

Brewer Overview

Helpful Hints

1. Plug the brewer into a mains socket by itself.

If the electric circuit is overloaded with other appliances, your brewer may not function properly.

2. For the best tasting gourmet coffee, tea or hot chocolate, Keurig recommends using bottled or filtered water.

Water quality varies from place to place. If you notice an undesirable taste in your cup of coffee, tea, or hot chocolate (such as chlorine or other mineral tastes) we recommend you consider using bottled water or water from a filtration system. For best results, carefully follow manufacturer's instructions when using any water filtration system.

3. Customise Your Size, Flavour & Brew.

With many varieties of K-Cup® pods to choose from and 3 brew sizes (170 ml (6 oz), 220 ml (8 oz), and 300 ml (10 oz) your Keurig® brewer gives you endless options to customise the size, flavour and brew that's perfect for you. For a strong, intense cup, select an Extra Bold K-Cup® pod (with up to 30% more ground coffee than regular

varieties) and the brew size that's right for you. The smaller the brew size, the more intense the flavour in your cup. The larger the brew size, the less intense the flavour in your cup.

4. Remove K-Cup® pod after use.

Please refer to page 7 for brewing instructions.

5. Brewing into a travel mug.

To brew into a travel mug, simply remove the Drip Tray Assembly and place the travel mug on the Drip Tray Base.

6. Descal the brewer regularly.

Please refer to pages 11 and 12 for instructions.

Unpacking the Brewer

1. Place the brewer box on a large steady surface (such as a table or countertop) or on the floor. Open the box.
2. Turn the box on its side with front of box face down.
3. Reach into the box and grasp the plastic bag that contains the brewer.

4. Carefully pull the plastic bag (and packaging materials) toward you and out of the box. The brewer will still be encased in the polyfoam and be on its side.
5. Remove the top polyfoam packaging material.
6. Carefully lift the brewer off of the bottom polyfoam and place it upright on a flat, steady surface.
7. Lift plastic bag off the brewer and remove the tape.
8. Record the serial number for this brewer on page 3 of this guide. The serial number can be found on the rating label on the back of the brewer.

We recommend you save all packing materials in case future shipping of the product is necessary.

WARNING:
Keep all plastic bags away from children.

Features K140 Brewer

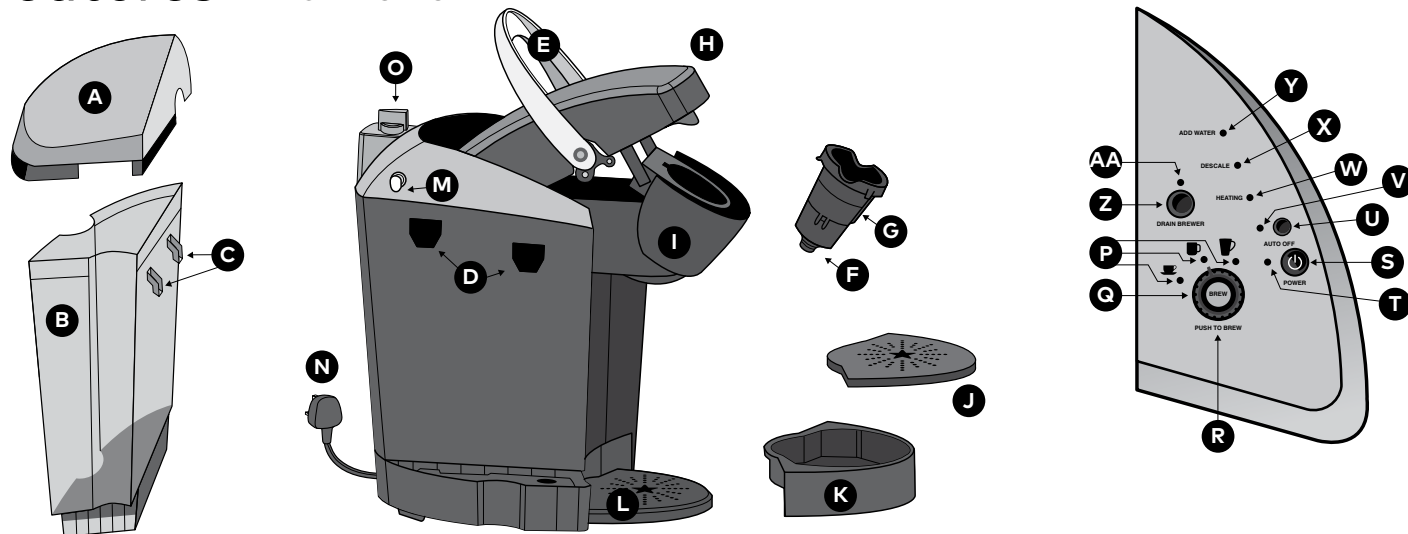

K140 Brewer

- | | | |
|---|---|---------------------------------------|
| A. Water Reservoir Lid | G. K-Cup® Pod Holder
(F and G are the
K-Cup® Pod Holder
Assembly) | L. Drip Tray Base |
| B. Water Reservoir | H. Lid | M. Vent |
| C. Lock Tab Slots | I. K-Cup® Pod Assembly
Housing | N. Power Cord |
| D. Water Reservoir
Lock Tab Slots | J. Drip Tray Plate | O. BREW/DRAIN
Selector Knob |
| E. Handle | K. Drip Tray | |
| F. Funnel | | |

Controls and Indicators (LED Control Panel)

- | | |
|---|--|
| P. Brew Size Indicator
Lights (Green) | X. DESCALE Light
(Amber) |
| Q. Selector Switch | Y. ADD WATER Light
(Blue) |
| R. BREW Button | Z. DRAIN BREWER
Button (used only
when packing away
for storage or travel) |
| S. POWER Button | AA. DRAIN BREWER
Light (Green) |
| T. POWER Light (Green) | |
| U. AUTO OFF Button | |
| V. AUTO OFF Energy
Save Light | |
| W. HEATING Light (Red) | |

SECTION 1 Set-Up & First Brew

IMPORTANT: You cannot use your Keurig® brewer until it has been set-up for its first use as set forth below.

NOTE: If the brewer has been exposed to temperatures below freezing, allow the brewer at least two hours to reach room temperature before brewing. A frozen or extremely cold brewer will not operate.



fig. 1

Setting Up Your Brewer

1. Unwrap the Power Cord and plug the brewer into the mains socket. Remove all pieces of packing tape.
2. Make sure the BREW/DRAIN Selector Knob is set to BREW (fig. 1).
3. Place a large mug, 300 ml (10 oz), on the Drip Tray Plate.
4. Remove the Water Reservoir from the brewer by first removing the Water Reservoir Lid (fig. 2), then lifting the Water Reservoir straight up and away from the brewer (may be tight). Rinse with fresh water.



fig. 2



fig. 3

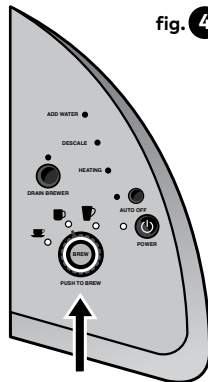

fig. 4

5. Fill Water Reservoir with bottled or filtered water. The water level should reach the line just below the top edge of the clear viewing area. **Do not overfill.**
6. Replace the Water Reservoir on the brewer. Replace the Water Reservoir Lid on the Water Reservoir.
7. Press the POWER Button (fig. 3) on the Control Panel. The green Power Light will come on. **NOTE: A K-Cup® pod should not be used for this sequence.**

NOTE: If the Water Reservoir is empty or not in place on the brewer, the blue ADD WATER Light will come on. The BREW Button will not work until water has been added to the Water Reservoir and the Water Reservoir is in place.

8. The brewer will automatically fill with water and then the water will be heated. This will take less than 5 minutes. During the heating period, the red HEATING Light will come on. Once the water is heated, the red HEATING Light will turn off and the selected brew size will come on. **NOTE: Do not lift Handle during this heating period.**

NOTE: You may see small amounts of water coming from the Vent and dripping into the Water Reservoir during this and subsequent heating – this is normal.

9. Lift the Handle then press the flashing blue BREW Button (fig. 4). Water will flow into your mug. When finished, pour the hot water away.
10. The brewer may take 20 seconds to reheat water between brews during which time the red HEATING Light may come on. When the water has heated, the red HEATING Light will turn off.
11. Your brewer is now primed and ready to brew your first cup.

Ready to Brew Your First Cup



fig. 5

1. The green light next to the POWER Button is on.
2. Place a mug on the Drip Tray Plate.
3. Lift the Handle and the K-Cup® Pod Holder will open toward you (fig. 5).
4. Select a K-Cup® pod.
NOTE: Do not remove the foil lid or puncture the K-Cup® pod.
5. Place a K-Cup® pod in the K-Cup® Pod Holder (fig. 6).
CAUTION: There are two sharp needles that puncture the K-Cup® pod, one above the K-Cup® Pod Holder and the other in the



fig. 6



bottom of the K-Cup® Pod Holder. To avoid risk of injury, do not put your fingers in the K-Cup® Pod Holder.

6. Lower the Handle all the way down to close the Lid.
7. Select the brew size you want by turning the Selector Switch to: small mug of 170 ml (6 oz), medium mug of 220 ml (8 oz) or large mug of 300 ml (10 oz). **NOTE:** If you do not push the flashing BREW Button within 60 seconds, it will be disabled to prevent accidental use. To start it again, fully lift and lower the Handle without removing the unused K-Cup® pod.
8. To start, press the flashing blue BREW Button. **CAUTION:** There is extremely hot water in the K-Cup® Pod Holder during the brew process. To avoid risk of injury, do not lift the Handle or open the K-Cup® Pod Assembly Housing during the brew process.
9. The blue BREW Button on the Control Panel will come on.
10. There may be a short pause before the brewing process begins. The entire brew process lasts for approximately 40 to 50 seconds and ends with a burst of air to remove all liquid from the K-Cup® pod. The blue BREW Button will go off.



Small
170 ml (6 oz)



Medium
220 ml (8 oz)



Large
300 ml (10 oz)

SECTION 1 Set-Up & First Brew

11. Lift the Handle and dispose of the used K-Cup® pod. **CAUTION: K-Cup® pod will be hot.**
12. Enjoy your first cup of Keurig Brewed® gourmet coffee, tea or hot chocolate! **NOTE: After brewing a hot chocolate K-Cup® pod, we recommend running a hot water brew cycle without a K-Cup® pod.**
13. The red HEATING Light on the Control Panel may come on as water is heated for the next brew cycle. The brewer will be ready to make another cup in about 20 seconds. **NOTE: During this period, your brewer will prepare for the next brew. The pump may make a vibrating sound. This is normal.**

Stopping a Brew

Press the POWER Button to turn the brewer off. **NOTE: If you cancel a brew in process, you may get less liquid in your cup on the next brew. We recommend you perform a brew without putting a K-Cup® pod in the brewer. The brew after that will be normal size.**

Adding Water

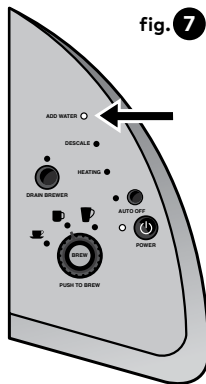

fig. 7

The blue ADD WATER Light will come on when the water level in the Water Reservoir is low or if the Water Reservoir has been removed (fig. 7). The brewer will not allow you to brew when the blue ADD WATER Light is on.

The Water Reservoir can be filled in two ways.

1. Remove the Water Reservoir Lid and pour water directly into the Water Reservoir while it is still attached to the brewer. Fill with bottled or filtered water. The water level should reach the line just below the top edge of the clear viewing area. **Do not overfill.** Replace the Water Reservoir Lid.
2. Remove the Water Reservoir from the brewer by first removing the Water Reservoir Lid from the Water Reservoir, then lifting the Water Reservoir straight up and away from the brewer. Fill with bottled or filtered water. Place the Water Reservoir back on the brewer and ensure the Water Reservoir Lock Tabs engage with the Lid on the Water Reservoir. **IMPORTANT: Do not remove the Water Reservoir during the brewing process.**

The blue ADD WATER Light will no longer be on three seconds after installing or refilling the Water Reservoir. This delay is normal.

Brewing Hot Water

Your brewer is able to produce hot water for use in cooking, making soups, porridge, etc. Simply lift and lower the Handle on the brewer without adding a K-Cup® pod. The blue BREW Button will flash. Be sure to have a mug on the Drip Tray Plate and then press the BREW Button.

SECTION 2

Controls & Indicators (LED Control Panel)

AUTO OFF Energy Save Feature

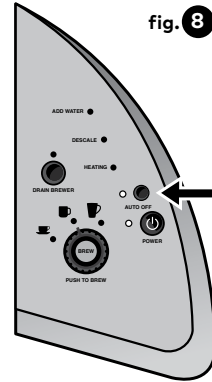

fig. 8

Your brewer is programmed to turn off after 30 minutes of non-use. When this feature is enabled, you will see the AUTO OFF Light illuminated green. (fig. 8)

To disable the AUTO OFF setting, and keep your brewer on at all times, press the AUTO OFF button so the green light turns off.

This means your brewer will now remain on until you press the AUTO OFF button again to illuminate the light and activate the feature, or press the POWER Button to turn the brewer off completely.

SECTION 3

Cleaning & Maintenance

Clean Regularly

1. Wipe external surfaces with a damp, soapy, lint-free, non-abrasive cloth. **NOTE: Do not immerse the base unit in water or other liquids.**
2. To clean the Drip Tray remove it by sliding it towards you, keeping it level to avoid spillage. The Drip Tray and Drip Tray Plate are dishwasher safe.

Cleaning the K-Cup® Pod Holder Assembly

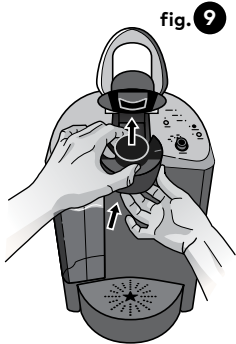

fig. 9

The K-Cup® Pod Holder Assembly can be placed onto the top shelf of a dishwasher. **NOTE: Use low temperature cycles in the dishwasher.** To remove from the brewer, lift the Handle and grasp the top of the K-Cup® Pod Holder with one hand while pushing up on the bottom of the K-Cup® Pod Holder from underneath with the other until it releases (fig. 9). After cleaning, align the K-Cup® Pod Holder with the opening using the two front ribs as a guide and snap into place from the top.

1. **Cleaning the Funnel**—The Funnel can be removed from the K-Cup® Pod Holder by pulling on it until it clicks off (fig. 10). The Funnel is dishwasher safe. To replace it, just snap it back onto the K-Cup® Pod Holder Assembly.

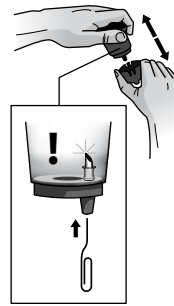

fig. 10

2. **Cleaning the Exit Needle**—The exit needle is located on the inside bottom of the K-Cup® Pod Holder Assembly. Should a clog arise due to coffee grinds, it can be cleaned using a paper clip or similar tool. Remove K-Cup® Pod Holder Assembly and detach Funnel. Insert the paper clip (fig. 10) into the exit needle to loosen the clog and push it out. The K-Cup® Pod Holder is dishwasher safe. **CAUTION: There are sharp needles that puncture the K-Cup® pod above the K-Cup® Pod Holder and in the bottom of the K-Cup® Pod Holder. To avoid risk of injury, do not put your fingers in the K-Cup® Pod Assembly Housing.**

Cleaning the Water Reservoir & Water Reservoir Lid

The Water Reservoir and Water Reservoir Lid should be periodically inspected and cleaned.

The Water Reservoir or Water Reservoir Lid should not be put into the dishwasher. They should be cleaned with a damp, soapy, lint-free, non-abrasive cloth and rinsed thoroughly. Do not dry the inside of the Water Reservoir with a cloth as lint may remain.

To clean the filter screen at the base of your Water Reservoir, empty the Water Reservoir and follow one or all of the following procedures.

1. Rinse the filter screen with the strong force of water from your faucet.
2. If you have a sprayer, aim the water spray at the filter screen.
3. Fill the Water Reservoir with approximately two inches of fresh water and agitate (shake) the Water Reservoir.

Empty the Water Reservoir then fill with bottled or filtered water and return to the brewer. If needed, repeat above procedures. **CAUTION: Please rinse the Water Reservoir thoroughly after cleaning. This will ensure that no cleaners or cleaning solutions remain in this area as they may contaminate the water supply in the brewer.**

Descaling Your Brewer

Depending on the mineral content of your water, calcium deposits or scale may build up in your brewer. Scale is non-toxic but if left unattended can hinder brewer performance. Regularly descaling your brewer every 3-6 months helps maintain the heating element, and other internal parts that come in contact with water. Calcium deposits may build up faster, making it necessary to descale more often.

Before you begin, you will need a large ceramic mug, fresh water, descale solution and access to a sink. Do not use a paper cup.

Properly follow the descaling procedure.

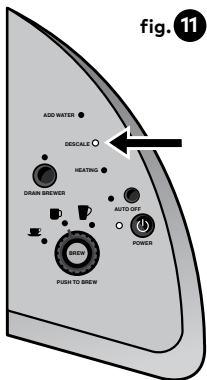

Descaling Procedure

Empty the water from the Water Reservoir. If there is a Keurig™ Water Filter, remove and set aside. Disable "Auto Off" features, if necessary (refer to page 9).

STEP 1: FIRST DESCALING SOLUTION RINSE

- Press the Power Button to power the brewer off.
- Pour the entire bottle of Keurig™ Descaling Solution into the Water Reservoir. Then fill the empty bottle with water and pour into the Water Reservoir. Press the Power Button to turn the brewer back on.
- Place a large mug on the Drip Tray Plate and run a cleansing brew using the largest brew size. Do not use a K-Cup® pod. Pour the contents of the mug into the sink.

STEP 2: SECOND DESCALING SOLUTION RINSE

- Repeat the brew process without a K-Cup® pod, until ADD WATER is indicated. Let brewer stand for at least 30 minutes while still on.
- After 30 minutes, discard any residual solution and rinse the Water Reservoir thoroughly.

STEP 3: FRESH WATER RINSE

- Ensure the Water Reservoir is filled with fresh water to and not beyond the MAX FILL line.
- Place a large mug on the Drip Tray Plate and run a cleansing brew using the largest brew size. Do not use a K-Cup® pod. Pour the contents of the mug into the sink.
- Repeat brew process until you have completed at least 12 brews using the largest brew size. You may need to refill the Water Reservoir at least one time during this process.

NOTE: If "DESCALE" is still indicated after completing the procedure, repeat the descaling procedure above.

SECTION 3 Cleaning & Maintenance

NOTE: The cleaning action of Keurig® Descaling Solution may result in a foam dispensed from the brewer. This is natural, as the solution is reacting with the scale inside. For a brewer that is heavily scaled, the brewer may not fill properly after the descaler is added. If this occurs, you may see only a small or no output dispensed followed by the sound of air blowing out. If this occurs:

- Turn off and unplug the brewer.
- If there is Keurig® Descaling Solution in the Water Reservoir, discard the contents, rinse the Water Reservoir thoroughly and refill with water.
- Plug the brewer back in, power on, and repeat the Step 3 Fresh Water Rinse cycle. The brewer should begin to function normally as the solution is rinsed out and the scale is removed. If problem persists, allow brewer to sit unplugged for at least 30 minutes before continuing with the rinse.

For further descale information please contact your Keurig Authorised Distributor.

Service

Beyond these recommended cleaning and maintenance procedures, this brewer is not user serviceable. For service, please refer to the Warranty section of this guide.

Draining the Brewer

The internal hot water tank of the K140 can be completely drained. We recommend that the brewer be drained if it is to be transported or stored for an extended period.

1. The brewer must be powered on and ready to brew.
2. Remove and empty the Water Reservoir and then replace it to the brewer. The ADD WATER Light will be come on.
3. Turn the BREW/DRAIN Selector Knob at the back of the brewer to DRAIN. The green DRAIN Light will come on.
4. Press and hold the DRAIN BREWER Button. Water will flow into the Water Reservoir. **CAUTION: The water may be very hot!**
NOTE: The process to drain a hot water tank from idle state takes about a minute.
5. When the water stops flowing, release the DRAIN BREWER Button. The internal hot water tank is now empty.
6. Empty the Water Reservoir and replace back on brewer.
7. Turn the DRAIN/BREW Selector Knob back to BREW and power off the brewer.

If you need assistance, please contact your Keurig Authorised Distributor.

Storage

Empty the Water Reservoir and drain the brewer before storing and take care to ensure that you store your brewer in a safe and **frost free** environment. We recommend you store your brewer in its **upright position**.

SECTION 4 Troubleshooting

SITUATION	SOLUTION	SITUATION	SOLUTION
Brewer does not have power	<ul style="list-style-type: none"> • Make sure the power is switched on at the socket. • Check to be sure that it is plugged in securely. • Try plugging the brewer into a different mains socket. • Reset your circuit breaker, if necessary. • Make sure the brewer has been turned on and the green POWER Light is on. 	Brewer shuts off automatically	<ul style="list-style-type: none"> • The AUTO OFF Energy Save Light will turn on after 30 minutes of non-use. This means that the brewer is in energy save mode. To enable for your next brew, press the POWER Button.
Brewer will not brew when used for the first time	<ul style="list-style-type: none"> • The brewer must be primed for the first brew (refer to page 6). • BREW/DRAIN Selector Knob must be set to BREW. • If brewer is cold/frozen, wait for two hours for it to reach room temperature before powering on. 	Blue ADD WATER Light, red HEATING Light and Brew Size Indicator Lights are all flashing simultaneously	<ul style="list-style-type: none"> • Completely remove the Water Reservoir and thoroughly clean (refer to page 10). Make sure the Water Reservoir is filled with bottled or filtered water. Return it to the brewer and make sure it is seated properly, then press the flashing BREW Button. • If you have completed the above procedure two times and the situation persists, contact your Keurig Authorised Distributor.
Brewer will not brew	<ul style="list-style-type: none"> • The BREW/DRAIN Selector Knob must be set to BREW. • After placing the K-Cup® pod in the K-Cup® Pod Holder, make sure that the Handle is all the way down and the blue BREW Button is flashing. • If the blue ADD WATER Light comes on, add water to Water Reservoir. Fill with bottled or filtered water. Make sure the Water Reservoir is seated properly in its base. • If the blue ADD WATER Light continues to be on even after refilling, contact your Keurig Authorised Distributor. 	Brewing a partial cup	<ul style="list-style-type: none"> • The exit needle may be clogged (refer to page 10). • Clean K-Cup® Pod Holder if necessary and rinse under a tap (refer to page 10). • The Water Reservoir may have been removed during brewing. Replace the Water Reservoir and perform a cleansing brew without a K-Cup® pod. • If the amber DESCALE Light comes on, descale the brewer (refer to page 11). • If you have repeated the descale procedure on your brewer two times and it is still only brewing a partial cup, contact your Keurig Authorised Distributor.

SECTION 4 Troubleshooting

SITUATION	SOLUTION
Water appears in the brewer base with the Water Reservoir removed	<ul style="list-style-type: none">• It is normal for a small amount of water (less than 10 ml (.34 oz)) to collect if the Water Reservoir is not seated for a period of time. This will not affect the operation of the brewer.• Use clean cloth or paper towel to absorb the water.• Return the Water Reservoir back to the brewer base.
All indicator lights are flashing simultaneously and brewer is unresponsive to button press	<ul style="list-style-type: none">• Unplug your brewer and contact your Keurig Authorised Distributor.

If any problems persist, contact your Keurig Authorised Distributor.

SECTION 5 Warranty

Warranty Information

What is covered by this warranty?

Keurig UK Limited ("Keurig") warrants that your Keurig® Model K140 brewer (the "brewer") will be free of defects in materials or workmanship when used in accordance with this use and care guide for one year from the date of purchase (the "warranty period").

This warranty only applies to Keurig® Model K140 brewers purchased directly from Keurig and operated in the United Kingdom; if you purchased your K140 brewer from a Keurig Authorised Distributor, you should look to such distributor to resolve any issues with your brewer, as this warranty does not apply.

What will happen if you file a claim under this warranty?

Keurig will either repair or replace the brewer without charge upon its receipt of proof of the date of purchase from Keurig and the brewer in accordance with the terms of this warranty. If Keurig chooses to replace the original product under this warranty, this warranty applies to the replacement product only during the remaining warranty period for the original product after which this warranty will expire and shall have no effect.

Keurig will reimburse the costs for returns of the brewer where this warranty applies if shipped with an ATR (as defined below) to the place designated herein and in accordance with Keurig's instructions.

What is not covered by the Limited Warranty?

1. This warranty does not extend to, and Keurig is not liable for:
 - i. any damages of any kind whatsoever which do not directly arise

from defects in materials or workmanship of the brewer. Such damages include without limitation property damage, any economic loss, loss of profit or goodwill, costs and expenses resulting from any breach of this warranty;

- ii. damages caused by any act, omission or services performed by anyone other than Keurig or its authorized service providers, use of parts other than genuine Keurig® parts, or external causes such as abuse, misuse, power supply or acts of God; or
 - iii. any express warranty, written or oral, other than the terms set out in this warranty.
2. Paragraph 1 does not affect, whether during or outside the warranty period:
- a. Keurig's liability in respect of:
 - i. death or personal injury caused by Keurig's negligence;
 - ii. any representation by Keurig which amounts to a fraud;
 - iii. loss or damage which arises from the brewer proving defective while in consumer use and results from the negligence of a person concerned in the manufacture or distribution of the brewer;
 - b. Keurig's liability in respect of:
 - i. Keurig not having the right to sell the brewer, the brewer not being free from any charge or encumbrance and your possession of the brewer as a purchaser being disturbed by third parties who claim their rights over the brewer;
 - ii. the brewer not corresponding with the description; or
 - iii. the brewer not meeting the standard that a reasonable person would regard as satisfactory, taking account of any description of the goods, the price and all other relevant circumstances.

How do you obtain warranty service?

Keurig® brewers are high quality appliances and, with proper care, are intended to provide years of satisfying performance. However, should the need arise for warranty servicing during the warranty period, simply call your Keurig Authorised Distributor. Please do not return your brewer to the address below for servicing without first speaking to Keurig Customer Service to obtain an Authorisation to Return number ("ATR"). Brewers returned without an ATR will be returned to the sender without servicing.

Keurig UK Limited, One Kingdom Street, Paddington Central, London, W2 6BD, United Kingdom.

This warranty and any non-contractual obligations arising from or in connection with it shall be governed by English law and this warranty shall be construed in accordance with English law.

In relation to any legal action or proceedings arising out of or in connection with this warranty (whether arising out of or in connection with contractual or non-contractual obligations)("Proceedings"), each of you and Keurig irrevocably submits to the exclusive jurisdiction of the English courts and waives any objection to Proceedings in such courts on the grounds of venue or on the grounds that Proceedings have been brought in an inappropriate forum.



To learn more about Keurig, visit www.Keurig.co.uk | www.Keurig.ie or contact your Keurig Authorised Distributor

Keurig UK Limited
One Kingdom Street, Paddington Central,
London, W2 6BD, United Kingdom

Pat. www.KeurigGreenMountain.com/patents

© 2015 Keurig Green Mountain, Inc.
All rights reserved

P/N 60-202826-000 Rev B
12/15